

FINSAUNA®

Therma 57 Indoor Sauna

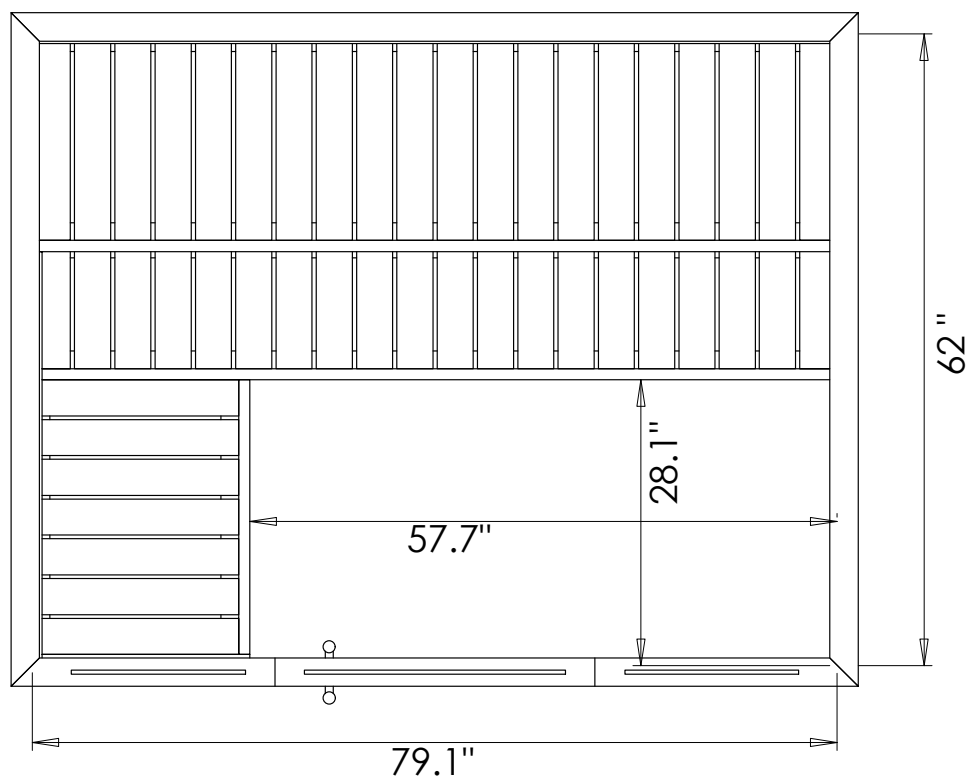

Note: Please read manual before construction

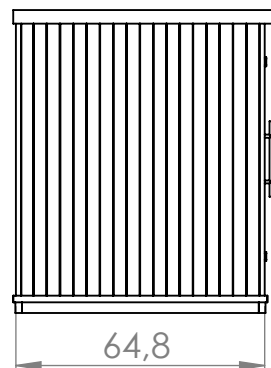
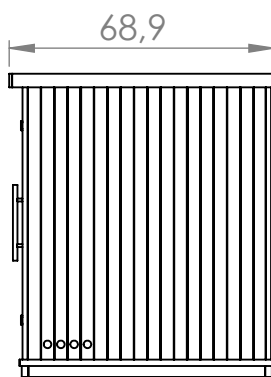
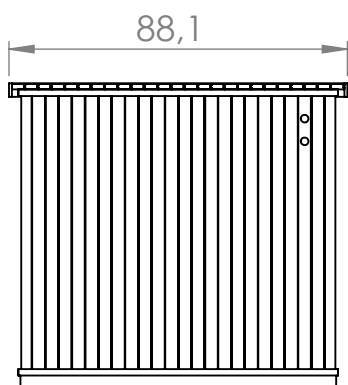
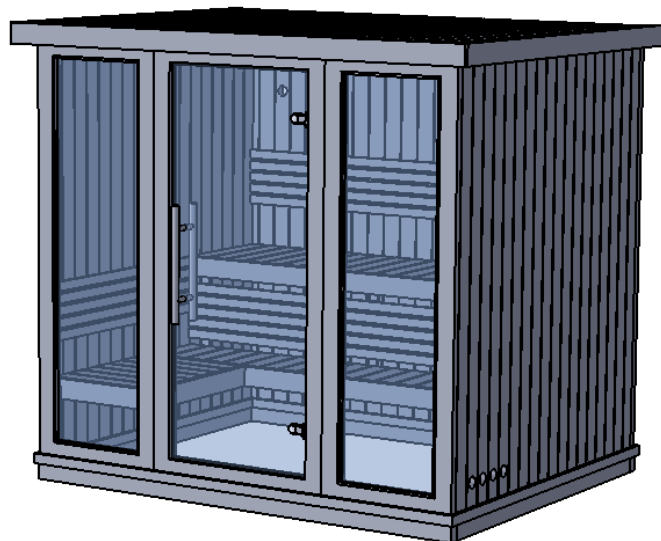
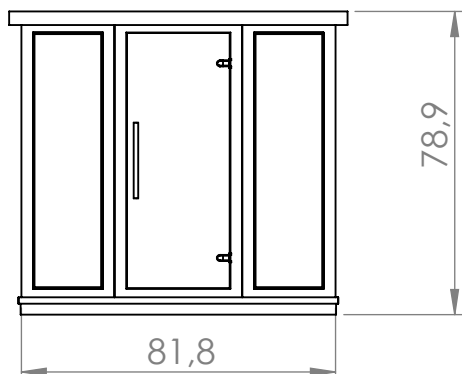

Your Finsauna Therma 57 sauna is specifically designed to utilize your existing floor. As such, assembly is made very simple since the entire sauna sits on pre-fabricated rails and risers. Your sauna can be assembled on any surface that is firm and flat, including concrete, ceramic, vinyl, laminate or tile. Installation on a carpeted surface is not recommended.

Therma 57 Kit Contents:

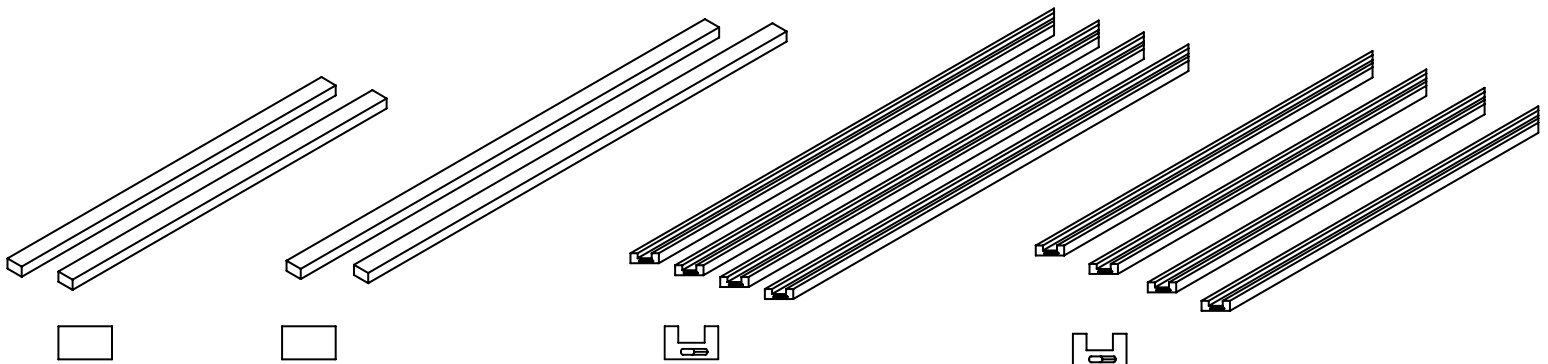

Floor raiser 1
(qty. 2)

Floor raiser 2
(qty. 2)

Support rail 1
(qty. 4)

Support rail 2
(qty. 4)

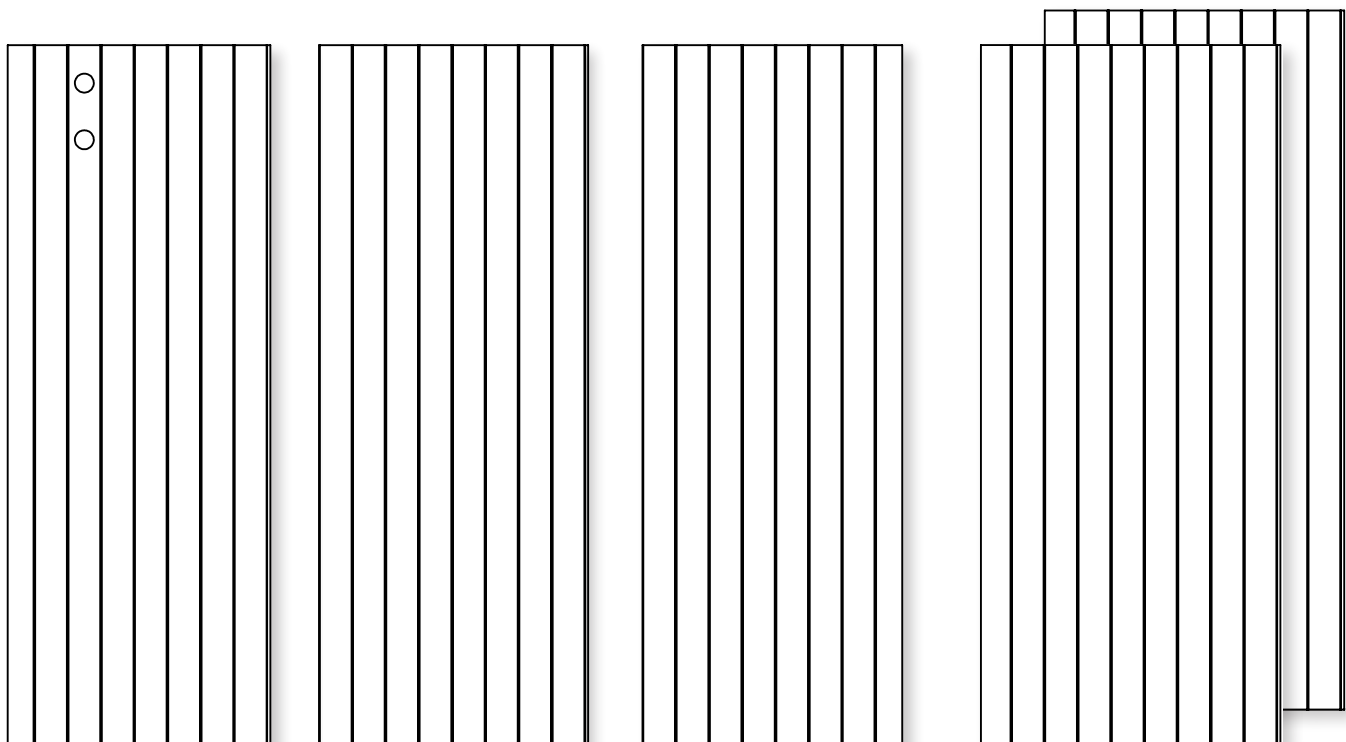

Back wall 1 (qty. 1)

Back wall 2 (qty. 1)

Back wall 3 (qty. 1)

Side wall 1 (qty. 2)

Therma 57 Kit Contents

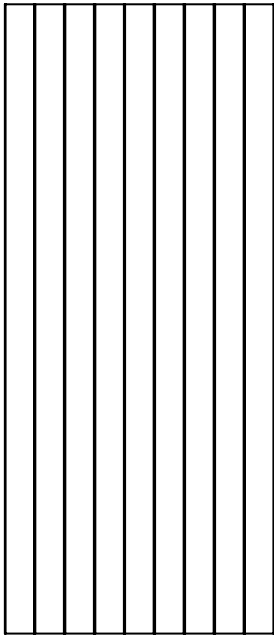

Side wall 2 (qty. 1)

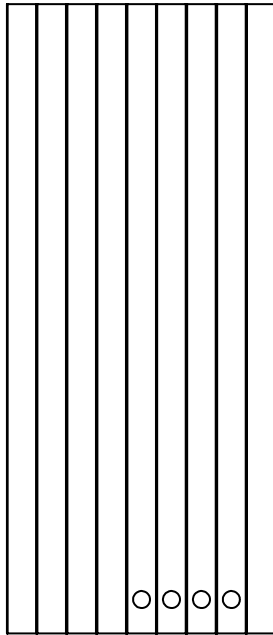

Side wall 3 (qty. 1)

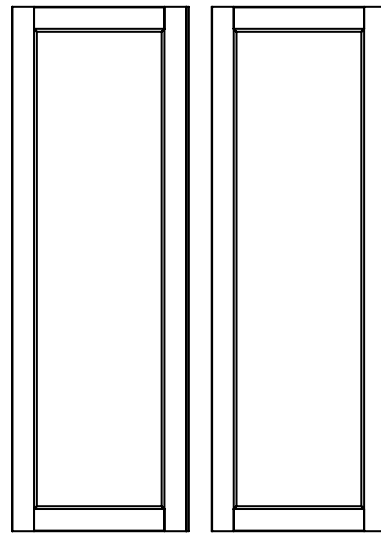

Window element (qty. 2)

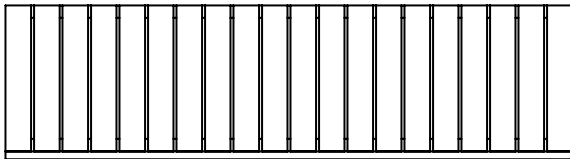

Bench (qty. 1)

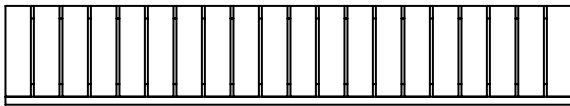

Lower bench (qty. 1)

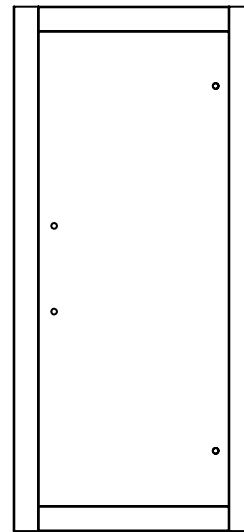

May be
configured left
or right-handed

Door element (qty. 1)



Backrest 1 (qty. 1)

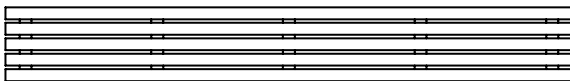

Backrest 2 (qty. 1)



Backrest 3 (qty. 1)



Roof 1 (qty. 1)

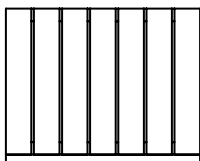

Side bench (qty. 1)



Roof 2 (qty. 2)

Therma 57

Kit Contents

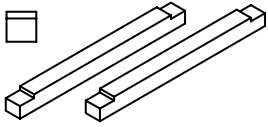

Bench support 1 (qty. 2)

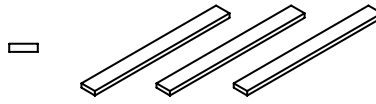

Backrest 2 vertical slat (qty. 3)

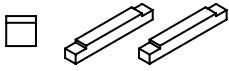

Bench support 2 (qty. 2)

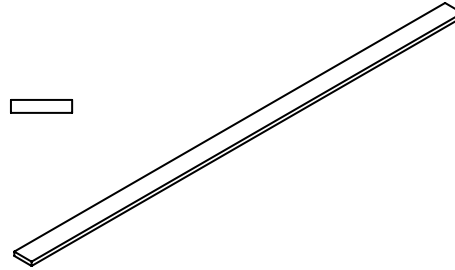

Cornice board 1 (qty. 1)

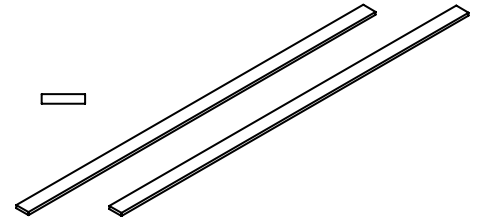

Front wall cover slat (qty.2)

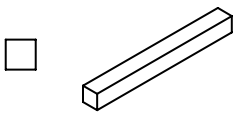

Side bench support 1 (qty. 1)

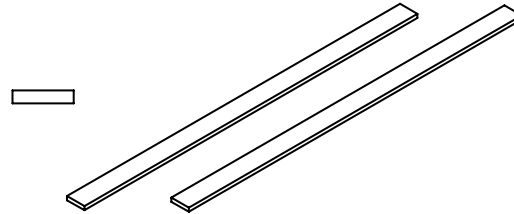

Cornice board 2 (qty.2)

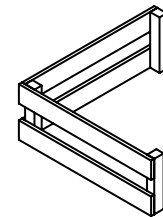

Heat fence (qty. 1)

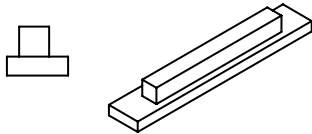

Side bench support 2 (qty. 1)

Screws	Qty.
4.5 x 80mm (.19" x 3.14")	8
4.5 x 70mm (.17" x 2.75")	47
4 x 60mm (.15" x 2.36")	8
4 x 50mm (.15" x 1.96")	50
3.5 x 40mm (.13" x 1.57")	28
3.5 x 35mm (.13" x 1.37")	6
3.5 x 25mm (.13" x .98")	9
3 x 20mm (.11" x .78")	16
Vent Cover Washer	1
Tenon	8

Tools required for assembly:

- Cordless drill
- Tape measure
- Rubber mallet
- Hammer
- 1/2" or 5/8" Forstner bit
- Utility knife
- Cordless screwdriver
- Screwdriver bits (Phillips & flathead)
- Level
- Step stool or ladder
- Framing square

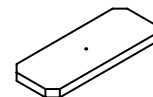

Vent cover (qty. 1)

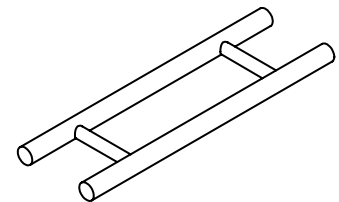

Door handle (qty. 1)

STEP 1.

Connect the Four Floor Risers

Fasten the four Floor Risers together using 4.5 x 80 screws. Be sure the two shorter boards are located on the sides and the two longer boards are on the front and back. Use a framing square to ensure that the assembly is square.

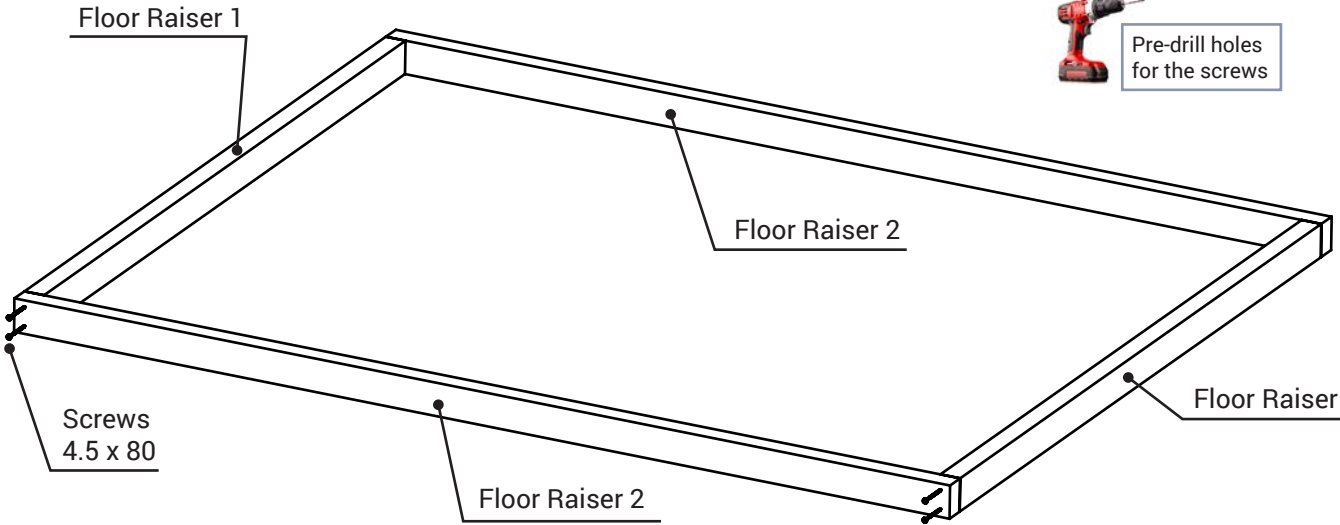

STEP 2.

Connect Wall Support Rails

Each wall support has a pre-drilled slot for the Tenon. Insert the Tenons in the longer support rail slots. Fasten the Wall Support Rails together and connect from corners using four 3 x 20 screws per corner.

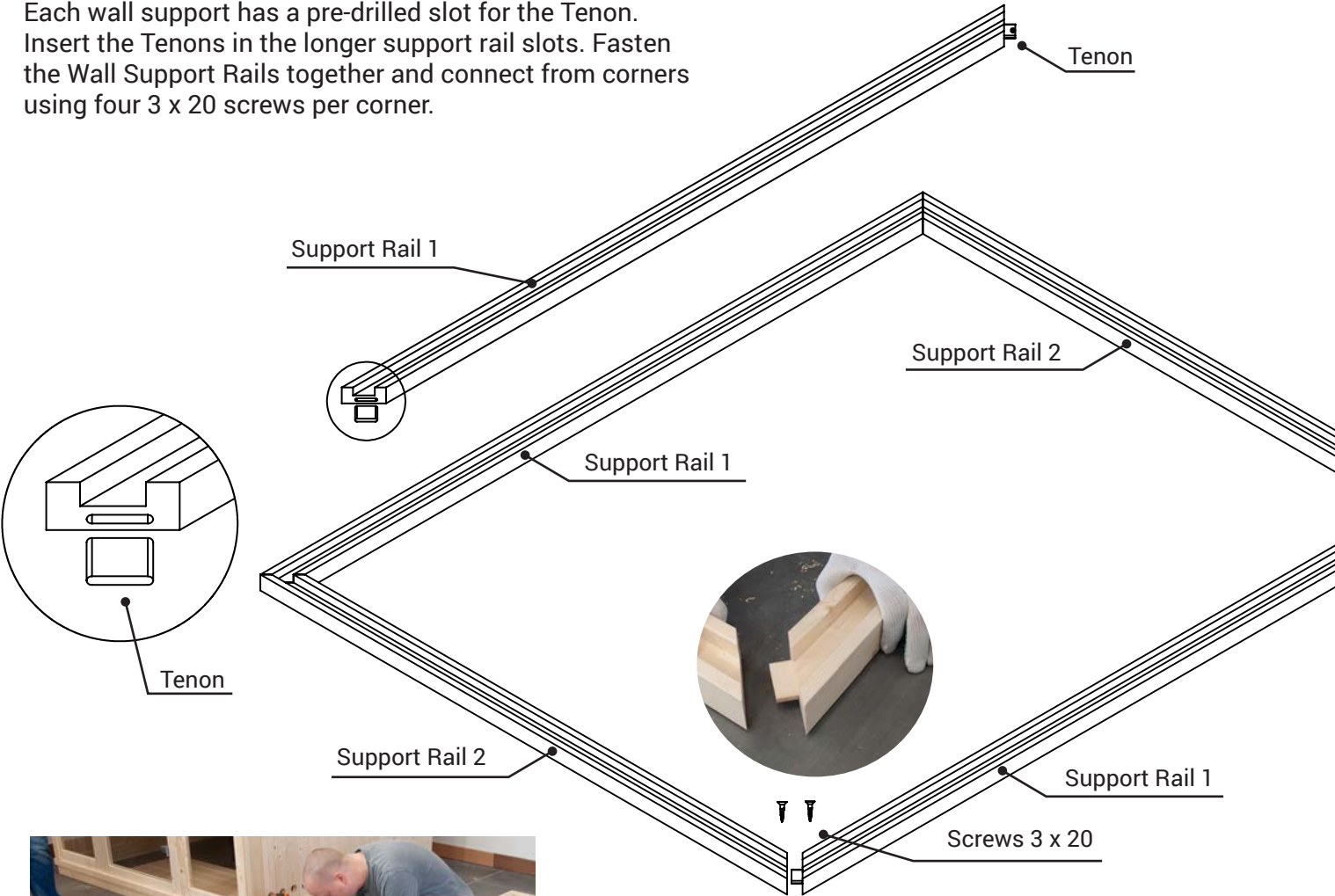

STEP 3.

Position Wall Support Rails

Lay the wall support rail assembly squarely on top of the floor risers with the groove facing up. The rails should overlap both sides of the riser by approximately 0.5". Secure the assembly to the floor risers using four 4 x 50 screws evenly spaced on each wall support rail.

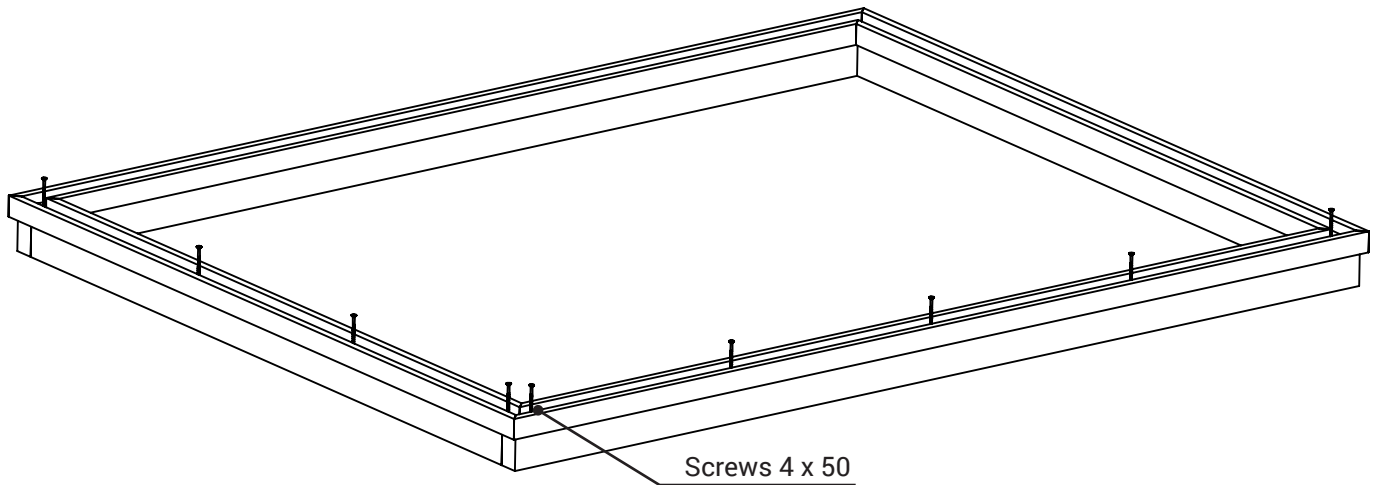

STEP 4.

Position Wall Sections (Back Wall 1 & Side Wall 1)

Position Back Wall 1 in the groove of the back rail and push it flush against the left rail. Have a helper hold the back wall section. Orient Side Wall Section 1 and place it in the groove of the left rail. Push the flat edge flush against back wall section. Align the two panels so they are flush and fasten them using 4.5 x 70 screws

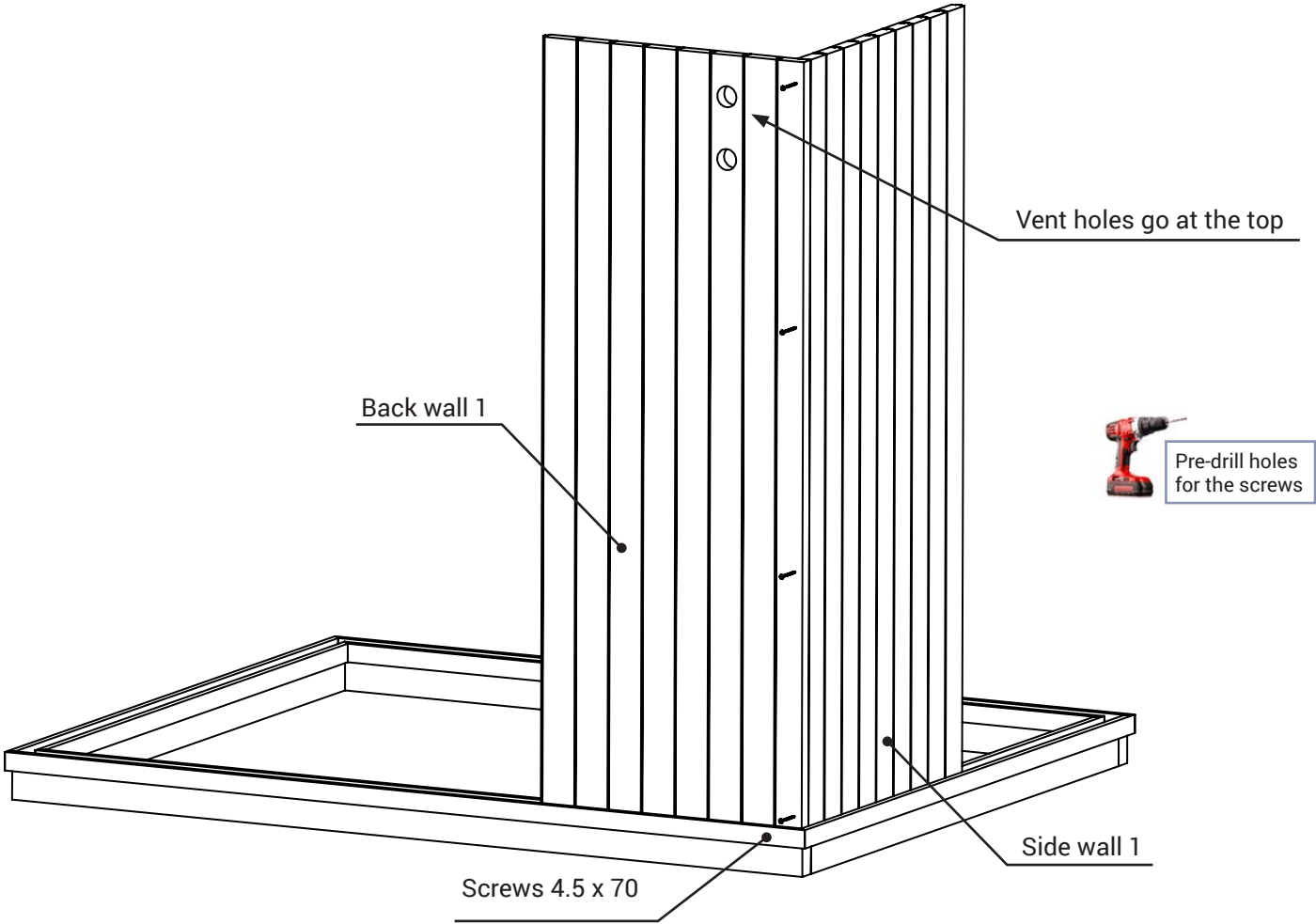

STEP 5.

Position Back Wall Sections 2 & 3, & Side Wall 1

Position Back Wall 2 section into the groove of the back rail. Attach it to Back Wall Section 1 by way of the tongue and groove fit. Secure it by tapping it into place with a rubber mallet. Repeat this step for wall section 3, again tapping it into place with a rubber mallet.

Position Side Wall Section 1 into the groove of the right side rail and push flush against the back wall. Be sure panels are flush with each other and fasten them together using the 4.5 x 70 screws.

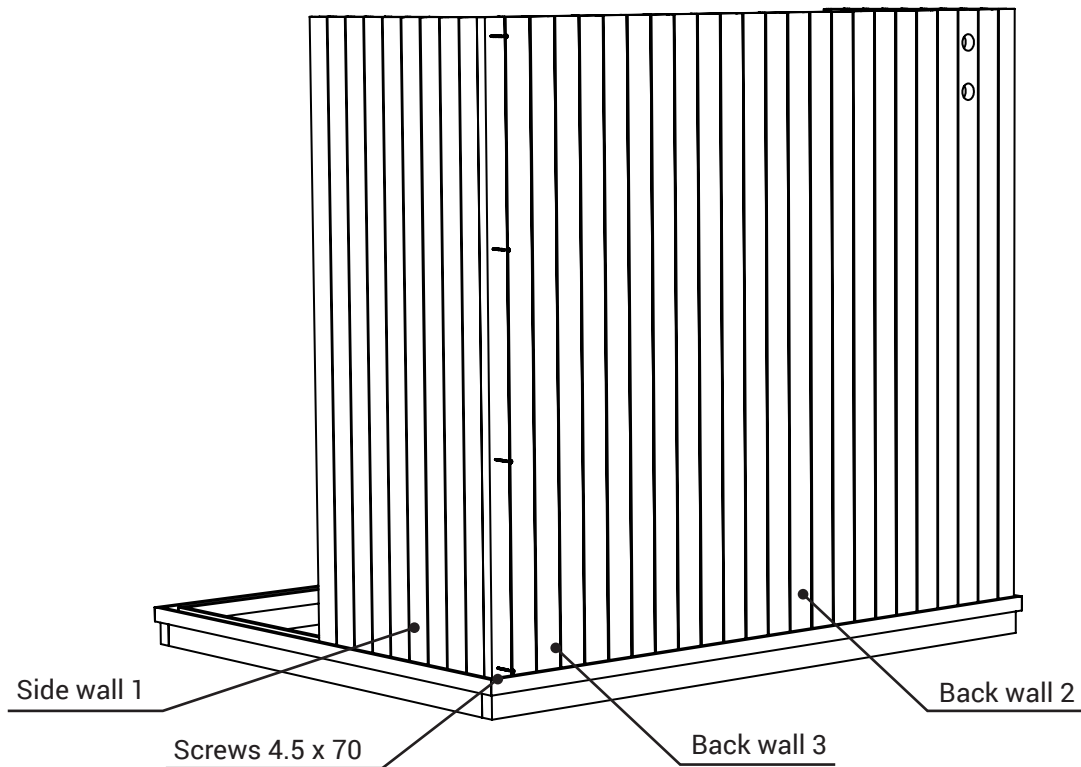

STEP 6.

Position Side Wall Section 2, Window Section & Door Element

Position Side Wall Section 2 into the groove of the side rail. Slide Side Wall Section 2 into place with Side Wall Section 1. Section 2 connects to Section 1 via tongue and groove so there is no need to use screws. Use a rubber mallet to secure the fit.

Place Window Section in the groove on the front rail and push against side rail. Being sure the two sections are flush, fasten them together using 4.5 x 70 screws.

Place Door Section onto the front rail orienting it so that the door opens according to your preference. Door Section connects to window section via tongue and groove so there is no need for screws. Gently tap it into place with a rubber mallet to secure the fit.

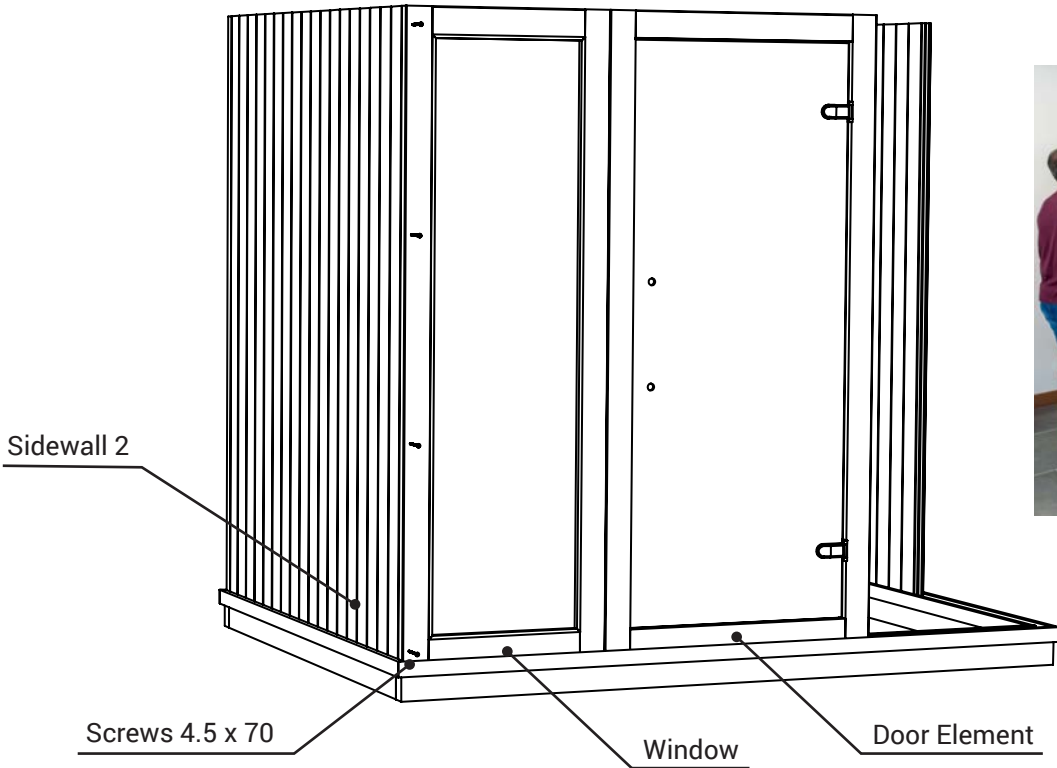

STEP 7.

Position Window Section & Side Wall Section 3

Position Side Wall Section 3 into the groove of the Side Rail orienting it so that the heater vent holes are located at the bottom. Slide the wall section into place with Side Wall section 1. Side Wall 3 connects to Side Wall 1 via tongue and groove so there is no need to use screws. Use a rubber mallet to secure the fit.

Next, place Window Section into the groove of the front rail and connect it to Door Section via the tongue & groove fit.

Gently tap into place with a rubber mallet to secure the fit. Now, making sure Window Section and Side Wall 3 are flush with each other, secure them together with the 4.5 x 70 screws.

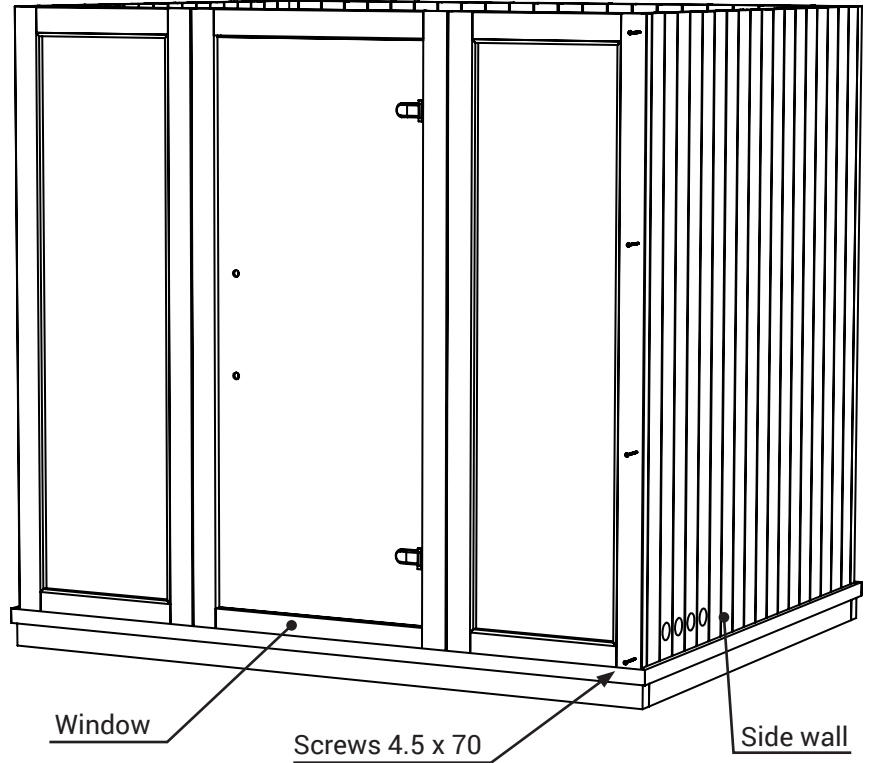

STEP 8.

Assemble & Position Roof Support Rails

Connect Roof Support Rails in the same way as Step 2. Place the assembly on top of the wall sections so that the wall sections fit snugly into the groove. When in place, secure to the assembly to the walls using four 4 x 50 screws on each rail.

Roof support rail

Screws 4.5 x 70

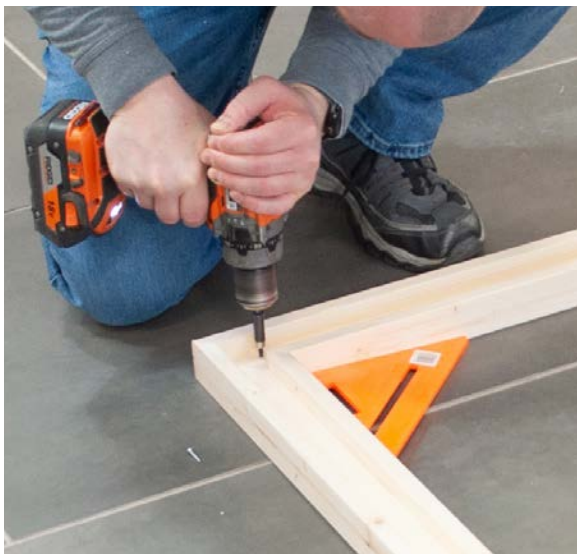
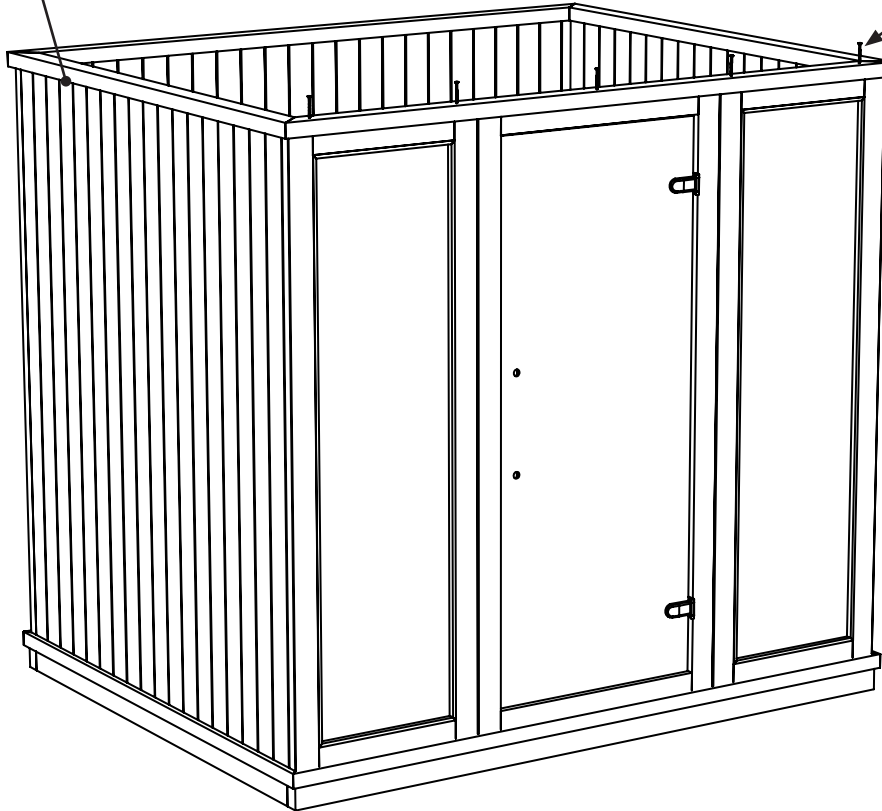

STEP 9.

Bench & Lower Bench Installation

Use 4.5 x 70 screws to connect the Bench Supports to the wall. Make sure the supports in both walls are the same height. When the supports are assembled, place the benches on the supports. Use three 4.5 x 70 screws to connect the Seat Bench to the Back Wall.

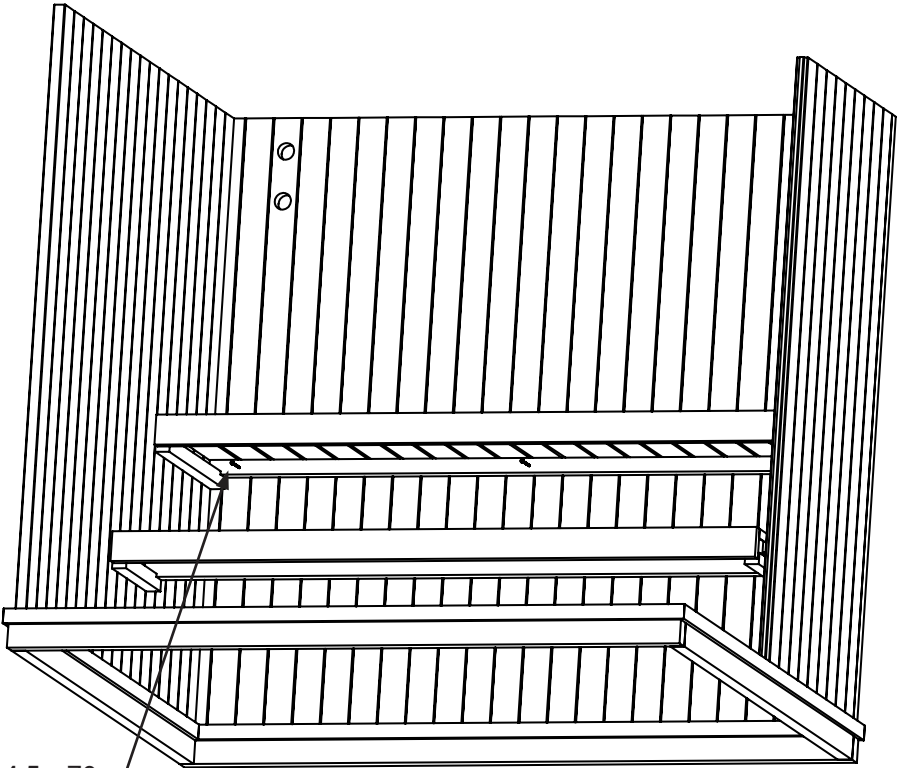
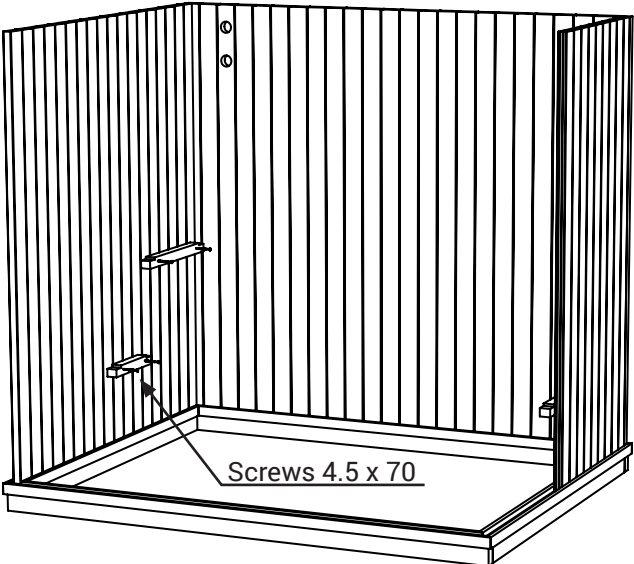
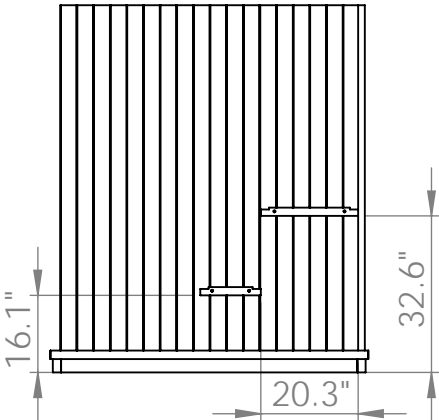

Screws 4.5 x 70

STEP 10.

Backrest Installation

Use 4.5 x 70 screws to connect the Bench Supports to the wall. Make sure the supports in both walls are the same height. When the supports are assembled, place the benches on the supports. Use three 4.5 x 70 screws to connect the Seat Bench to the Back Wall.

Step 1

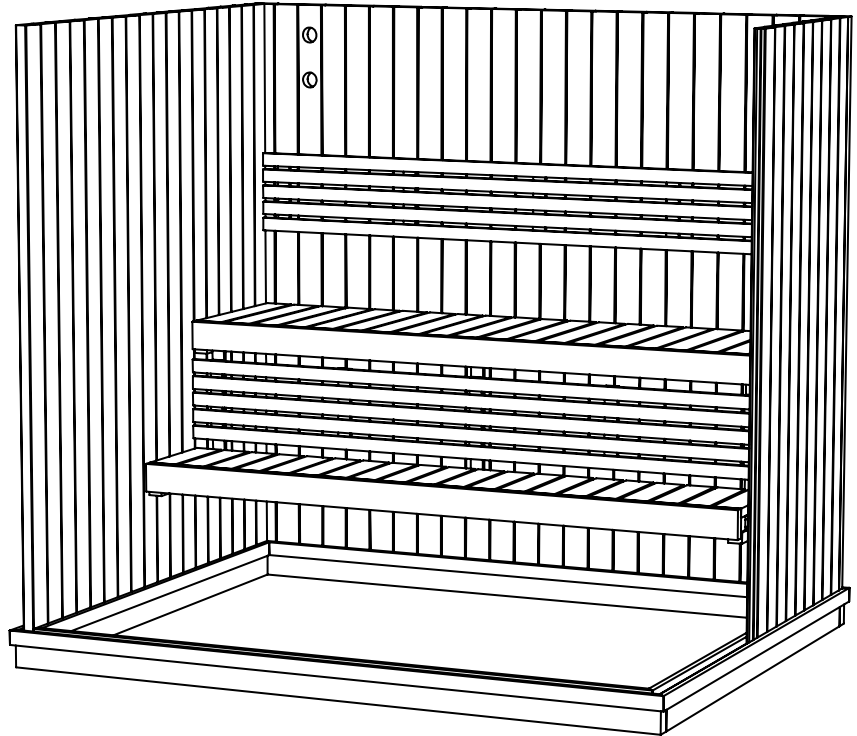
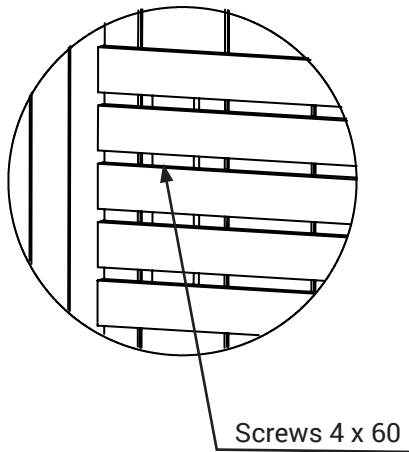

Therma 57 Indoor Sauna Room

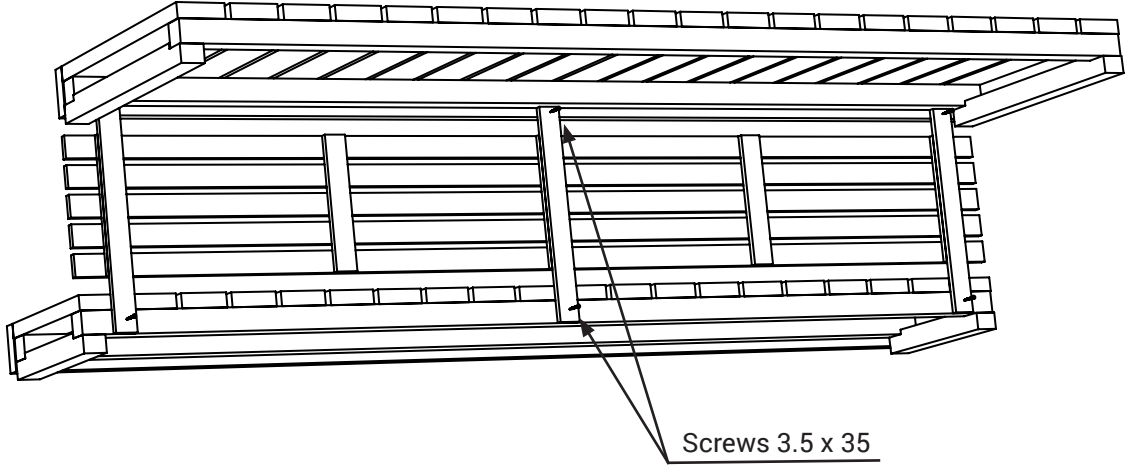
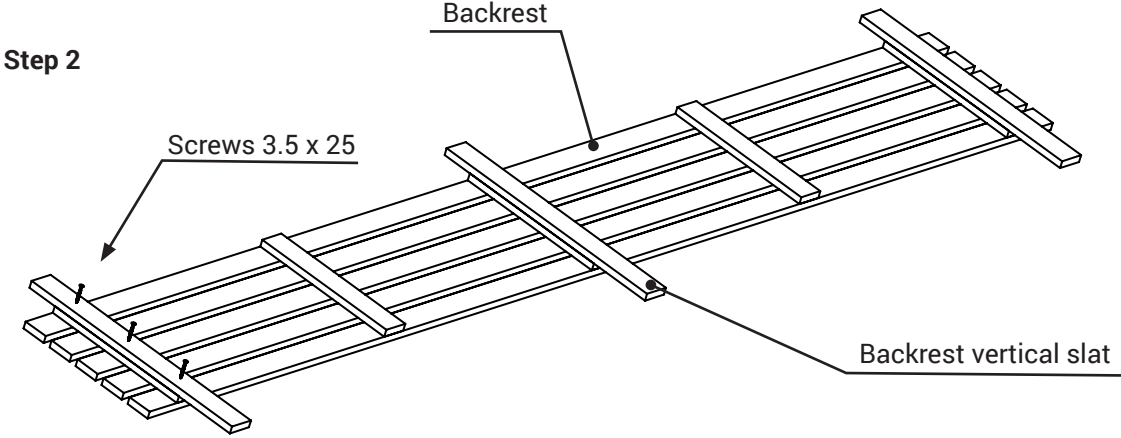

STEP 11.

Side Bench Installation

Attach the Side Bench Support 1 to the Lower Bench, using two 4.5 x 70 screws. The gap between the support and the side wall must be 2". Side Bench Support 2 connects to the window section using 4 x 60 screws. Support must be in the same height with lower bench. Place the Side Bench on the supports and fasten with two 4.5 x 70 screws to the side wall element.



Pre-drill holes for the screws

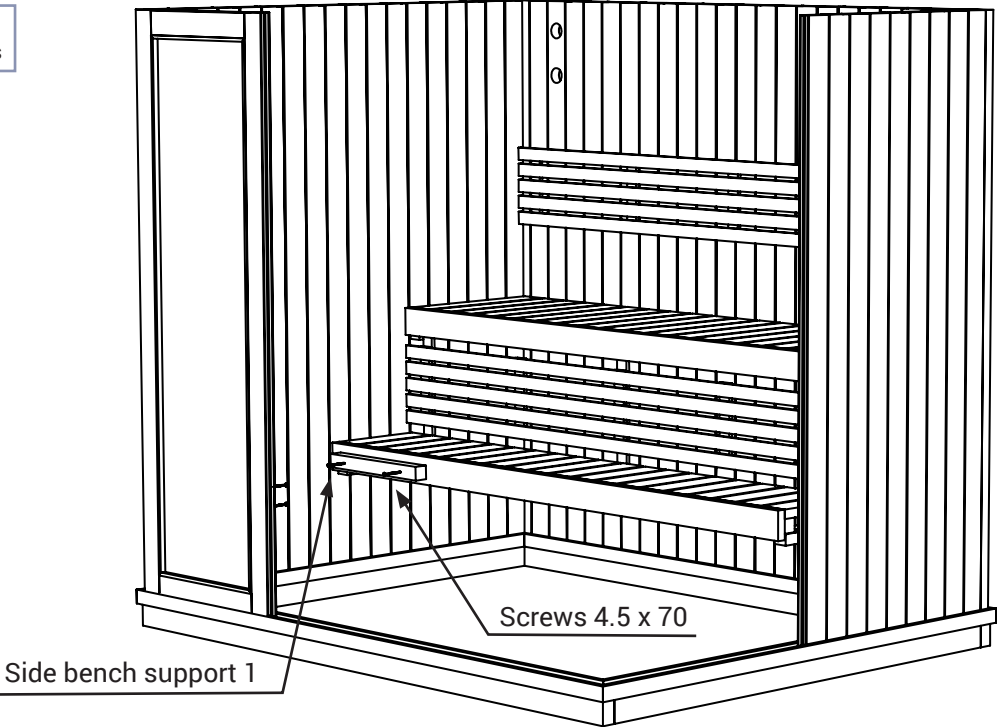

Therma 57 Indoor Sauna Room

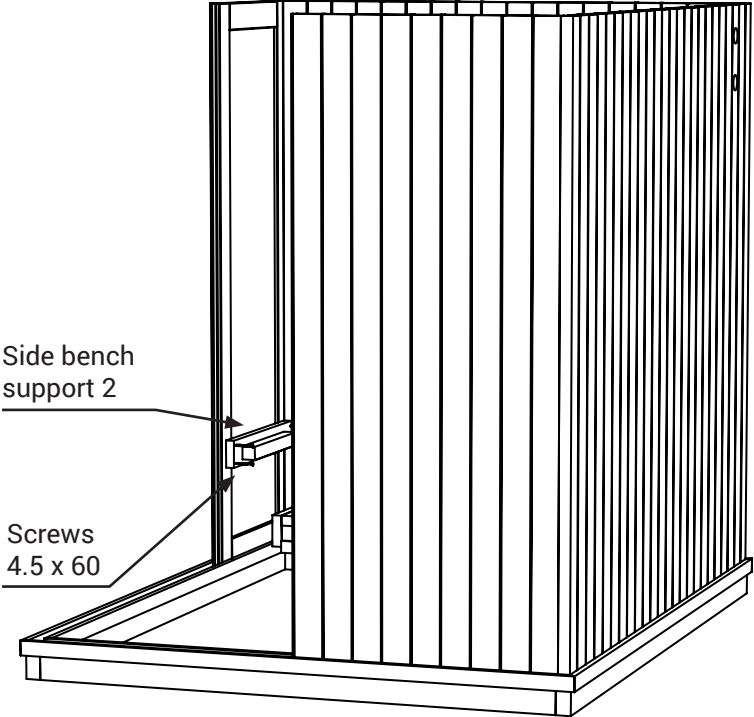
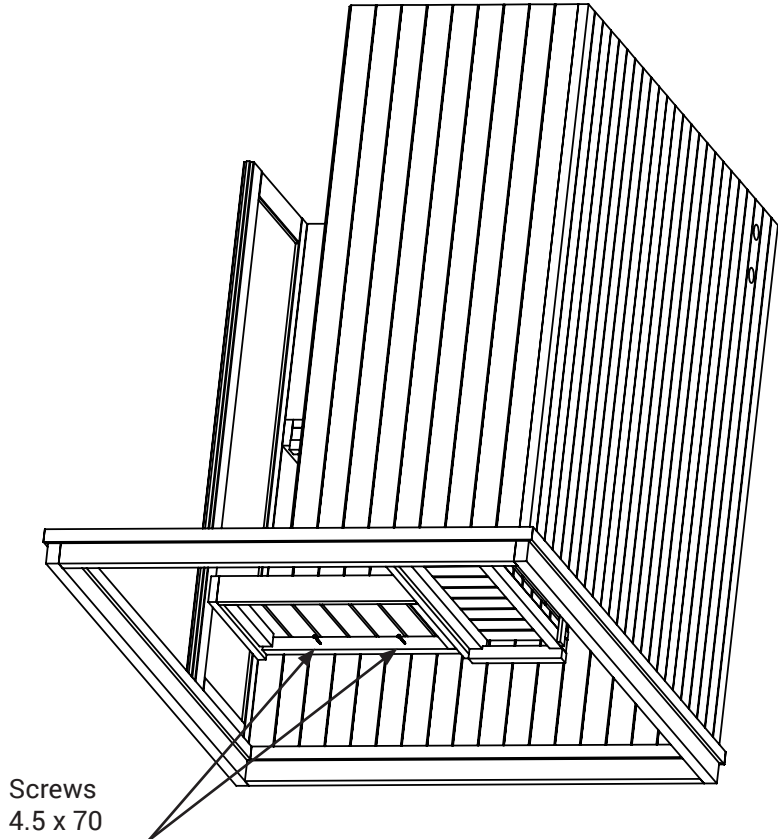

STEP 12. Position Roof Sections

Place the Roof Panels on top of the Ceiling Supports. Connect the sections via the tongue and groove fit. From the backside, roof panels must be in the same line with ceiling supports. Position both sides equally. Connect panels with 4 x 50 screws.

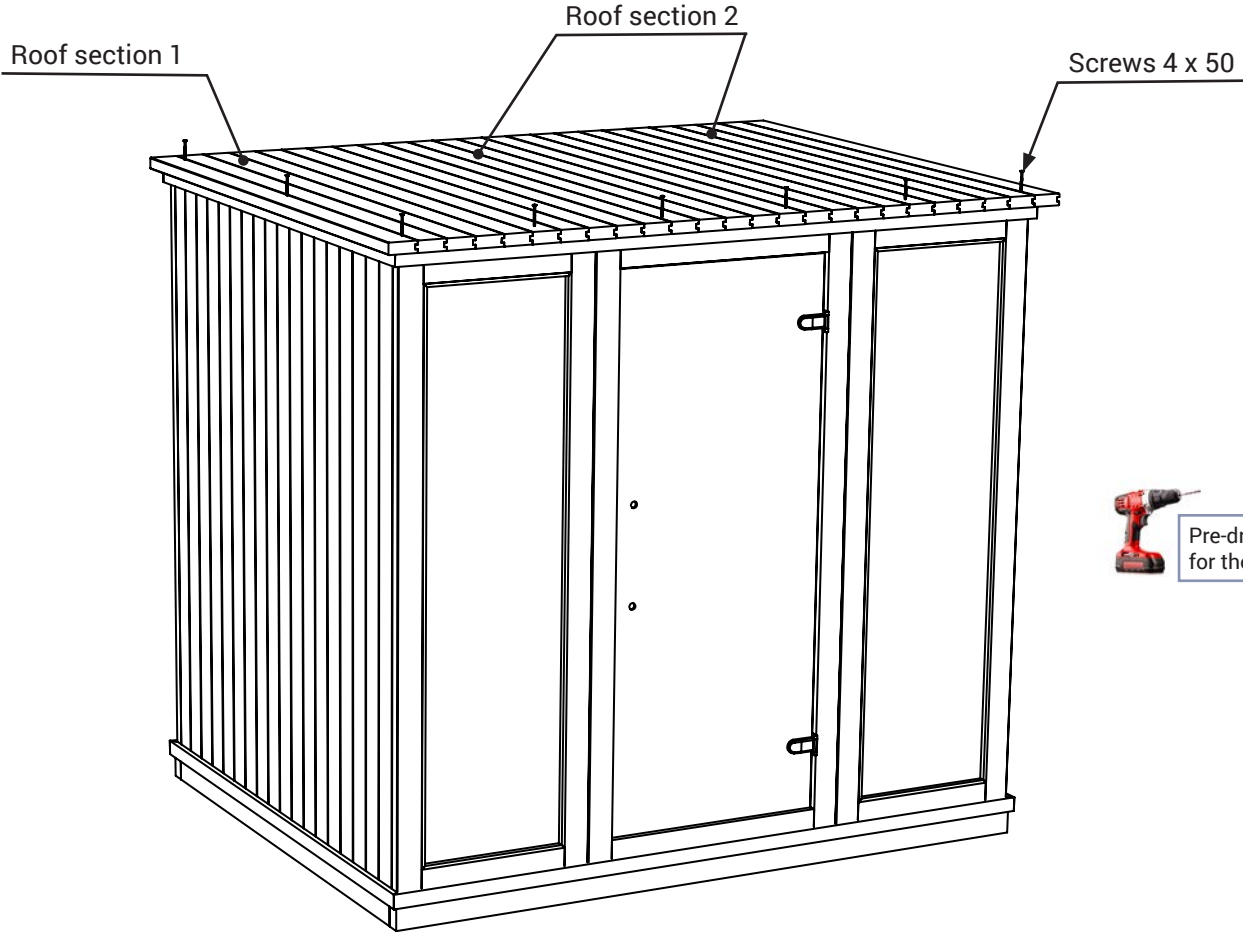

STEP 13.

Cornice Boards

Connect the cornice boards to the roof using 3.5 x 40 screws.

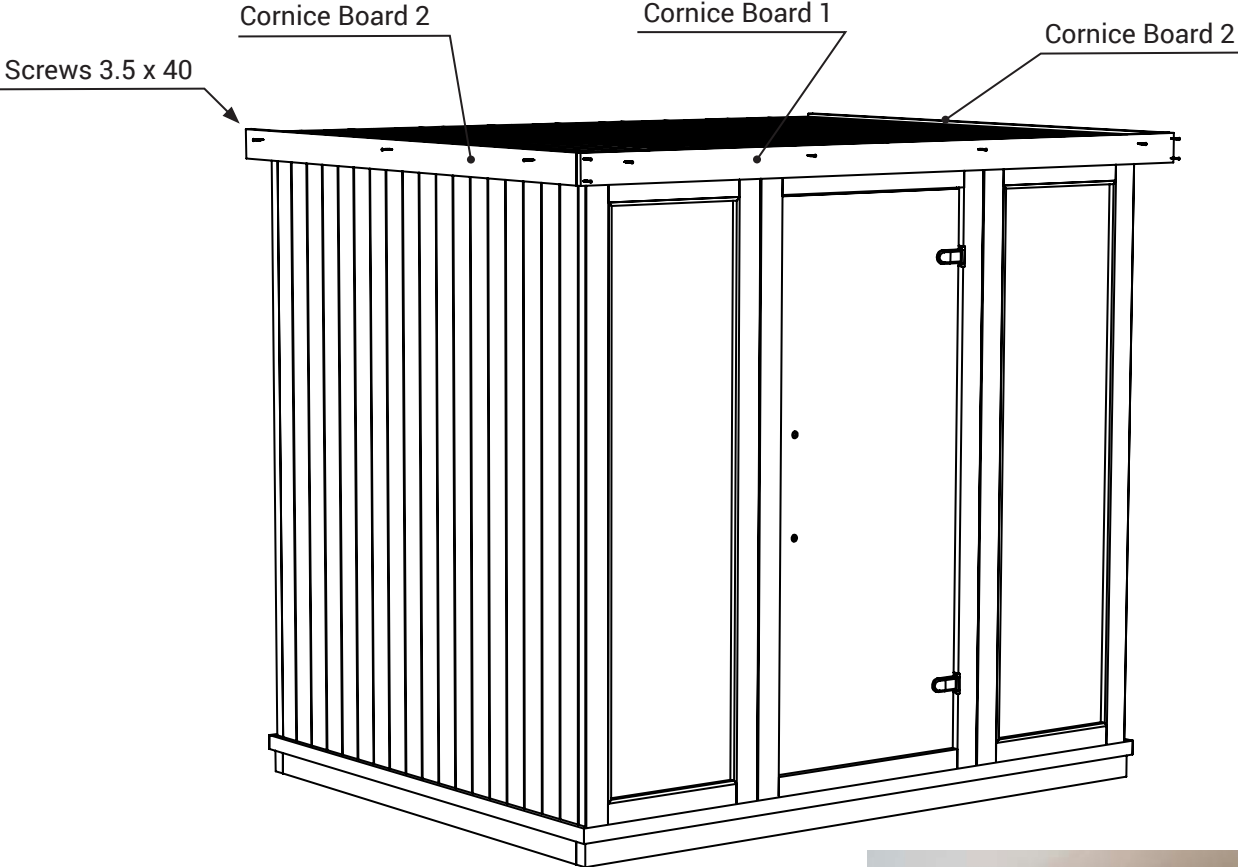

STEP 14.

Vent Cover & Door Handle

Connect vent cover with 3.5 x 40 screw. Add a small washer between the wall & vent cover.

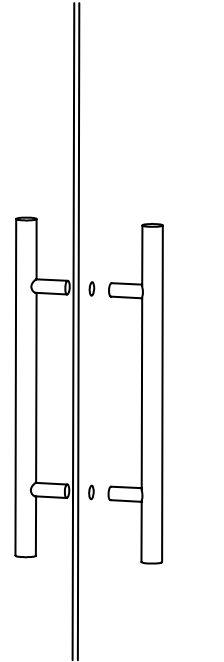
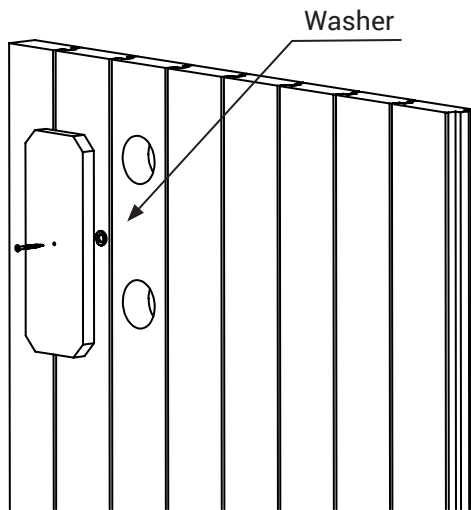

STEP 15.

Heater Fence

Connect the Heater Cover to the wall with 4 x 60 screws. Perform this step after heater is installed.



Pre-drill holes for the screws

Note: Follow heater manufacturer recommended installation for heater guard.

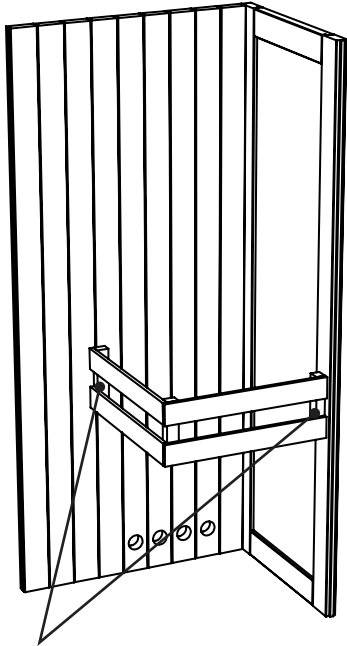

Screws 3.5 x 60

STEP 16.

Cover Slats for the Front Wall

Connect the Cover Slats using 3.5 x 40 screws.

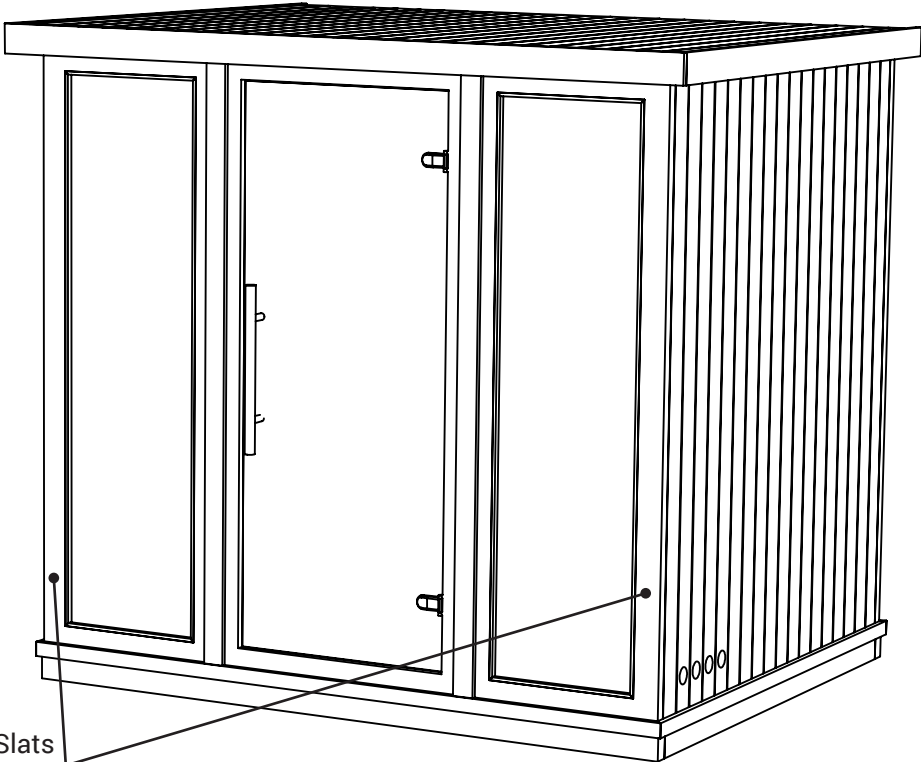

Cover Slats

Sauna Care Guide

Surface preparation:

- Soil underneath the sauna should be removed and replaced with a well-drained and load-bearing material.
- It is important to ensure that the surface is load bearing. In addition, it is important to inhibit the growth of vegetation beneath and around the sauna to prevent damage from moisture.
- Bring the power cable to the sauna in accordance with the heater manufacturers' manual.

During sauna use:

- When using the heater and the control unit refer to the operation manual provided by the heater manufacturer.
- Throw water only on the stones and not on the walls or the platform.
- To keep the benches looking fresh, we advise using seating pads or a towel on the bench.
- Avoid sitting on benches in wet swimwear.
- Sauna stones will naturally erode over time. Replace old stones with new ones or add new stones.
- Avoid use of non-approved cleaning agents. For example, bleach on the wood surface will discolor it.

After sauna use:

- After using the sauna, ventilate the room well to allow the surfaces to dry.
- Wipe benches with a clean, damp cloth. Keep excess water from pooling on wood surfaces. Do not use a stream of water to wash the platforms.
- After cleaning the sauna, ventilate the room and allow surfaces to dry. Remove seating pads from the benches.
- When not using the sauna, the door should remain closed.

Annual maintenance:

- The wood in the sauna should be treated with an approved cleaning solution (sauna cleaner).
- Wash all surfaces exposed to wear with a specialized sauna cleaning solution (sauna cleaner), using a soft brush and/or cloth. Follow the directions of the cleaning solution manufacturer.
- For stronger stains and soiling, the platform surface can be cleaned gently using fine-grade sandpaper. The platform or sanded surface should then be re-treated with protectant.

Avoid the following:

- Drying textiles such as carpets and clothing etc. as this may pose a safety hazard. Excessive moisture may also damage the surface of the wood.
- Do not heat the sauna to a temperature beyond the specifications of the heater manufacturer. Excessive heat may cause the wood to warp or pose a safety hazard.
- Avoid pressure washing or using a stream of water to clean the sauna, as excess moisture may permanently damage the wood surface and structures.



FINSAUNA SAUNA LIMITED WARRANTY

Finsauna extends this Limited Warranty solely to the original retail consumer purchaser of Finsauna products purchased from one of its authorized resellers.

LIMITED SAUNA WARRANTY

Finsauna warrants that its products shall be free from defects in workmanship under normal conditions of use and service for two years for residential applications after delivery to the original retail purchaser. This warranty is limited to making good any factory assembled component which in the judgment of Finsauna is deemed defective in workmanship. The warranty does not cover normal material wear, abuse, natural weathering of the lumber, or installation or delivery of components and applies only to the original retail purchaser.

WARRANTY PERFORMANCE

For any warranty service, Finsauna reserves the right to choose, at its option, repair of the problem or a replacement of the defective part. Finsauna reserves the right to substitute a part or component of equivalent value, either new or factory reconditioned, and any such repair or replacement shall assume as its warranty only the remaining portion of the warranty on the original product. In the event Finsauna chooses to repair any malfunction or defect covered by this warranty, a return authorization will be issued, and the component will be returned prepaid freight to Finsauna for repair of the defect. Finsauna will then ship the component back to the original retail purchaser upon completion of the repair. Prior to any return, contact Finsauna at: Finsauna, 511 Glenn Avenue, Wheeling, Illinois 60090, telephone number: (800) 957-2862, for packaging and shipping instructions and a return authorization number. In addition, Finsauna will require photographs of any defect and reserves the right to inspect or designate an agent to inspect any part that is claimed to be defective and covered by this warranty. Labor charges and related expenses for removal, installation, or replacement of the product or component are not covered under this warranty. Normal wear and tear, cosmetic issues or changes to individual pieces of lumber due to natural aging and weathering are not covered.

ACTS INVALIDATING WARRANTY

This warranty is void if the Finsauna product has been subject to alteration, misuse or abuse, commercial use, or if any repairs on the sauna are attempted by anyone other than an authorized representative of Finsauna. Alteration shall include, but is not limited to, deviation from the original assembly instructions, component change, or the addition of any non-approved device or heating system, which contributes to a component or unit failure, or unsafe operating system. Use of equipment in an application for which it is not designed will void this warranty. This includes, but is not limited to, damage caused by operation above safe operating temperatures, damage caused by added components, damage caused by harsh chemicals, damage caused by movement of the product, and damage caused by acts of God.

DISCLAIMERS

The Warranty does not cover naturally occurring and expected characteristics of wood materials (differences in wood grain, knots, slight variations in tone) and phenomena that occur naturally during use of the Product (shrinkage and expansion due to temperature and humidity, moderate deformation) and the visual disturbances they may cause, nor defects (including transport damage) that would have been detectable by visual inspection prior to installation of the Product. Except as expressly provided above, Finsauna makes no other representation or warranty, express or implied, either in fact or operation of law, statute, or otherwise, and Finsauna specifically disclaims any and all implied or statutory warranties, including warranties or merchantability and of fitness for a particular purpose. Finsauna shall not be liable for loss of use of the Finsauna product or other incidental or consequential costs, expenses, or damage, which may include but are not limited to, the removal of or reinstallation of a wall, deck or other fixture, water leakage, costs of shipping or packaging, applicable taxes, or the payment of any costs or expenses of disassembly, removal, or reinstallation of the product or any part. Your rights may vary from state to state. Under no circumstances shall Finsauna or its representatives be held liable for injury to any person or damage to any property, however arising, even if caused by the Finsauna Sauna or its representatives' negligence. No distributor, salesperson, dealer, retailer, or other representative of Finsauna has the authority to alter or change these warranties either orally or in writing.

FINSAUNA[®]

Finsauna is a Bathing Brands company © Bathing Brands, Inc 2024